



## **markilux** spotlight LED

The elegant light bar with adjustable LED spotlights  
in an aluminium housing



### The elegant light bar ...

with adjustable LED spotlights in a powder-coated aluminium housing

one radio receiver and one special hand-held radio transmitter ensure convenient operation at the touch of a button

the brightness can be dimmed using the hand-held radio transmitter and the light colour can be adjusted from soft white to daylight white (3000 to 5500 Kelvin)

# Quantity of brackets and LED spotlights and their distance from one another

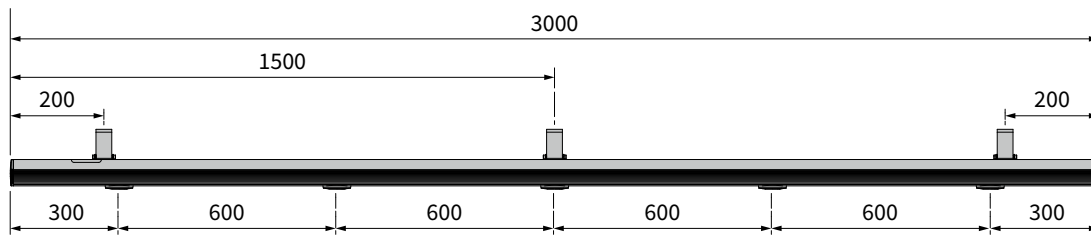

markilux spotline LED with 5 spotlights and 3 brackets

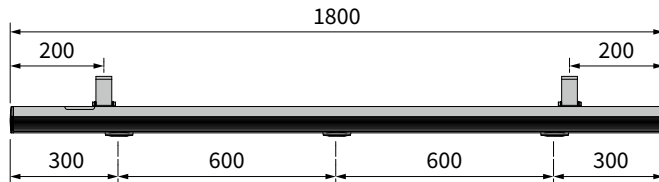

markilux spotline LED with 3 spotlights and 2 brackets

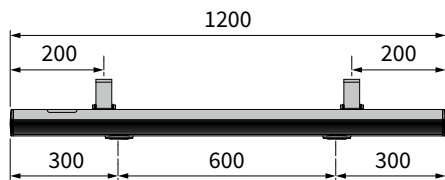

markilux spotline LED with 2 spotlights and 2 brackets

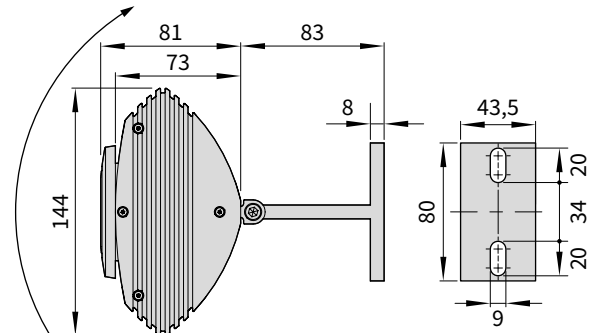

side view of the markilux spotline LED illustrating face fixture dimensions in mm

## Housing colours

		standard	optional
traffic white	RAL 9016		
metallic aluminium	RAL 9006		
grey brown	similar to RAL 8019		
off-white textured finish	5233		
stone grey metallic	5215		
anthracite metallic	5204		
Havana brown textured finish	5229		
non-standard powder-coated finish			

Colours similar to those in the RAL chart. Colours may differ slightly from those depicted in both hue and finish.

\* not compatible with Somfy radio controls

## Technical data for LED spotlights

power supply	230 V, 50 Hz ~
protection category	protected against water spray IP 24
protection class	I
wiring cross section	H05RN-F 3G 3 × 1.0 mm <sup>2</sup>
power output (per spotlight)	4 Watts
light intensity range	0—100 %
colour temperature range	3000—5500 Kelvin

No. of spotlights	2	3	5
length	120 cm	180 cm	300 cm

## Technical specification of the radio remote control\*

transmission frequency	433.92 MHz
battery	CR 2032, 3 Volt

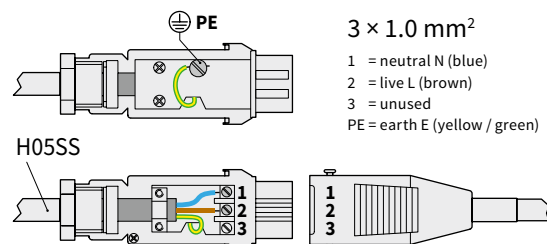

connecting plug (Hirschmann STAK3 connector)

## Fixtures, fittings and accessories

Brackets for fixture of 2 markilux spotline LEDs to the markilux syncra 2

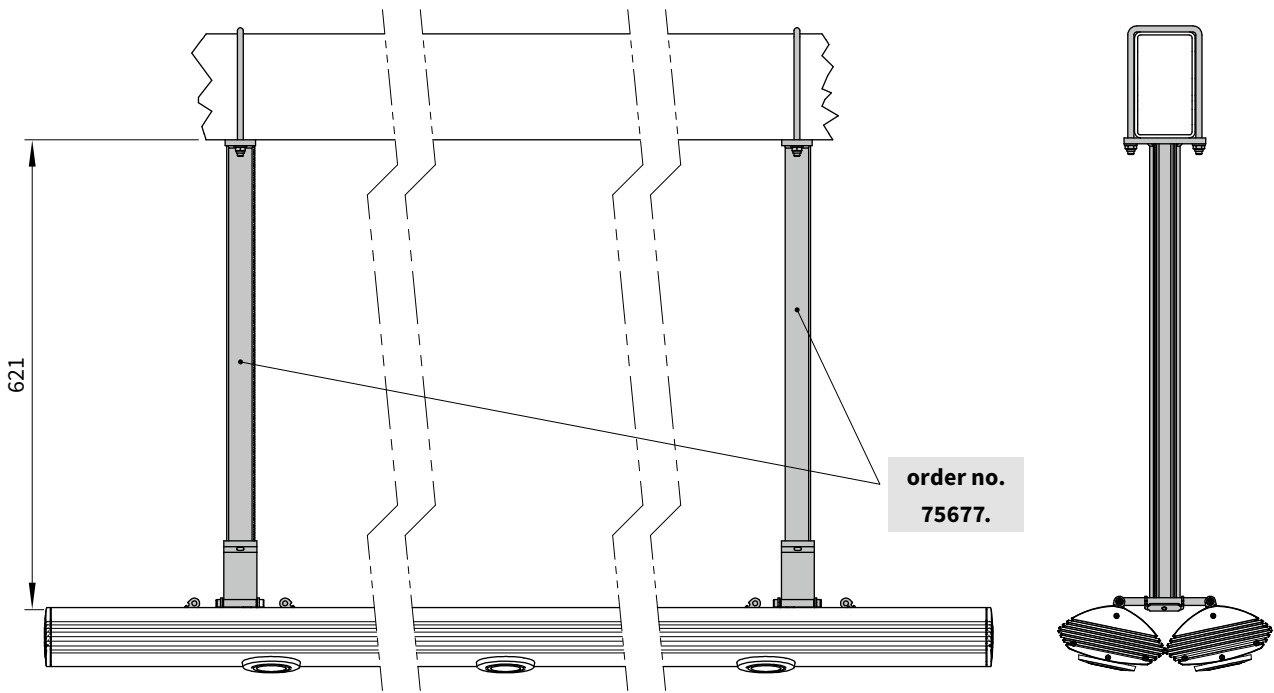

Brackets for fixture of the markilux spotline LED to the markilux syncra 2

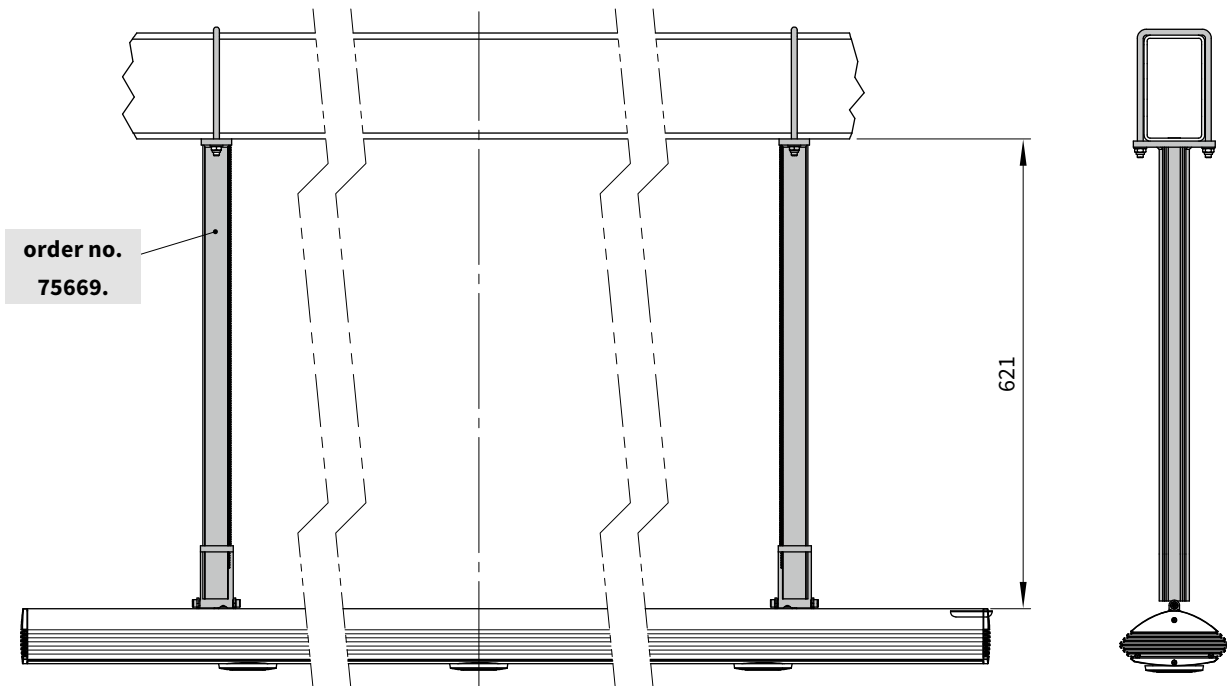

dimensions in mm  
. = insert RAL colour code no.



### Fixtures, fittings and accessories

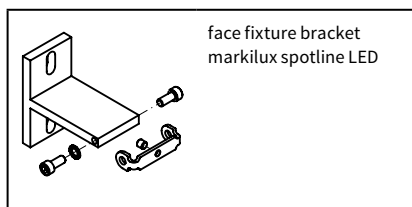

face fixture bracket  
markilux spotline LED

**71284.**

#### Additional brackets for the markilux infrared heater, E-Box, etc.

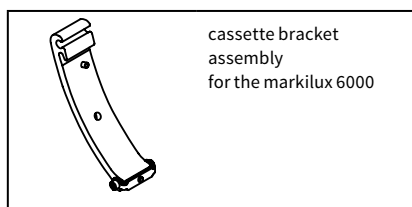

cassette bracket  
assembly  
for the markilux 6000

**71282.**

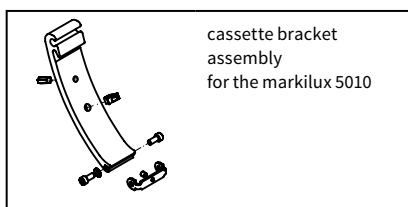

cassette bracket  
assembly  
for the markilux 5010

**71283.**

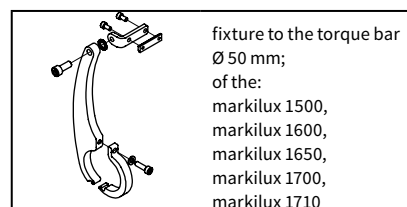

fixture to the torque bar  
Ø 50 mm;  
of the:  
markilux 1500,  
markilux 1600,  
markilux 1650,  
markilux 1700,  
markilux 1710

**71278.**

. = insert RAL colour code no.